

Data Sheet



Article number: 0121059

Description: Retaining ring JL 42X1,75
Spring steel

Measures

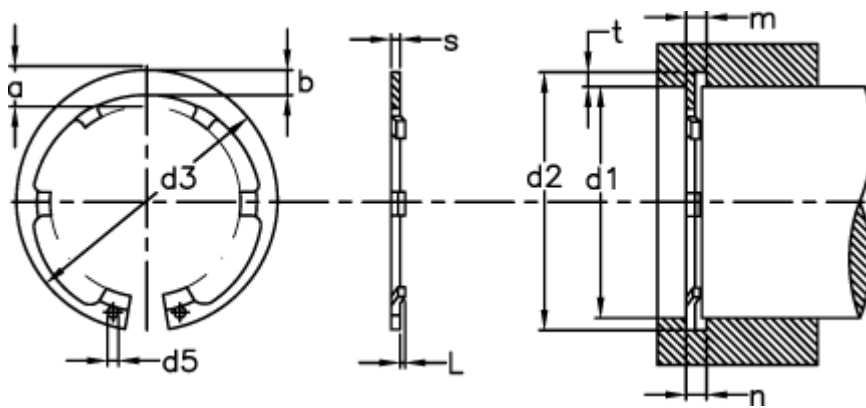

a max	= 7.2	FL max kN	= 1.10	s	= 1.75
b	= 4.1	FN kN	= 28.4	tol	= 0.25
C kN/mm	= 2.44	FRg kN	= 8.40	tol	= +0,90 -0,39
d1	= 42	FR kN	= 44.70	u	= 0.10
d2	= 44.5	g	= 2.0		
d3	= 45.5	L min	= 0.55		
d5 min	= 2.5	m min	= 1.85		
Description	= AL 42	Nominal drive	= 3.8		